

Development and Fabrication of a Wood Gasifier to Power an Internal Combustion Engine

Simon Chinguwa, Wilson R. Nyemba, Tien-Chien Jen

Department of Mechanical Engineering Science, Faculty of Engineering and the Built Environment, University of Johannesburg, Auckland Park 2006, Johannesburg, South Africa
chinguwa@gmail.com, nyemba@yahoo.com, tjen@uj.ac.za

Kudzai Boora,

Department of Mechanical Engineering, University of Zimbabwe, P O Box MP 167, Mount Pleasant, Harare, Zimbabwe
kudzboor13@gmail.com,

Abstract

Fossil fuels have been the main source of energy for many years hence the depletion of resource. There is therefore a need for alternative cleaner energy sources of fuel to be explored. The use of these conventional fuels led to land degradation global warming and air pollution. A wood gasifier machine which produces combustible gas from solid fuels like charcoal, wood and agriculture residue was designed. The combustible gas can be used for heating purposes or to produce mechanical or electrical energy. There was a great literature search for the technology currently being used for gasification processes which led to the design and manufacture of the gasifier prototype which was tested and came out successfully. An internal combustion engine was run on the combustible gas. Gasification bi-products that came out were tar and ash which could be used for water proofing and fertilizer respectively. Biofuels are renewable energy sources and are carbon neutral as they do not increase the total amount carbon dioxide in the atmosphere. The test also revealed some shortcomings in the design. The air which was used to allow for combustion to take place was inadequate, hence there is a need for further research.

Keywords

Carbon, Combustion, Fossil Fuels, Gasifier

1. Introduction

The demand for alternative energy sources is on a gradual increase in order to avoid the usage of fossil fuels which have various negative environmental impacts. Water and Air pollution, climate change and the need of independent power supply are the major driving factors making renewable energy grow in popularity as it is cleaner and cheaper (Jacobson, 2010). The other reasons for the search for alternative energy sources is due to the increase in consumption of fossil fuels and the depletion of the reserves (Sharma, 2016). A gasifier is a machine that uses biomass as fuel to produce electrical or mechanical power. In the gasifier, the biomass is converted into combustible gas called syngas or producer gas. Syngas can be used for heating or to produce mechanical or electrical power. The combustion of syngas can be used to provide heat for boilers, and or the syngas can be used as the combustible fluid for an internal combustion engine. The gasification bi-products are tar, which can be used for water proofing, and ash which can be used as fertilizer. The syngas is composed of the combustible gases hydrogen, carbon monoxide and methane, produced as a result of incomplete combustion of the carbon containing fuel. The most common biomass fuels for gasifiers are charcoal and wood. Agricultural residues like maize cobs and rice husks, can also be used as fuel for the gasifier. Gasifiers can be employed for small scale renewable energy power generation for rural areas, small industries or in agriculture for irrigation (Nanthavong & Xayalath, 2008). Gasifier machines for large scale applications can produce more than 500kW of power (FAO, 1986).

Energy production using the gasification technique has been in existence for many years, initially developed for cooking and lighting (Stassen, 1995). Coal, charcoal and wood gasifiers were extensively used to produce syngas for internal combustion engines during World War 2, due to shortage of petroleum. Trucks, buses and agricultural machines were also powered by the gasifiers, thus the vehicles were operating on domestic solid fuel (FAO, 1986). However due to abundance of petroleum after the war, and the availability of cheaper oil, the gasification technology became less popular. Biomass fuels e.g. wood, are carbon neutral, they do not increase the amount of carbon dioxide in the atmosphere (Rafidah et al, 2011). Carbon dioxide is a greenhouse gas which is transparent to incoming solar radiation (visible light) but opaque to the outgoing terrestrial radiation (infrared), thus traps heat in the atmosphere. The production and consumption of energy is most fundamental to creating wealth and sustaining livelihoods. Fossil fuels have been the major source of energy in the past, but due to emissions that are hazardous to animal health and ecosystem, there is need for alternative sources of energy that are eco-friendly.(Mpofu, 2016)

2. Background and Literature Review

Furniture companies and or wood processing companies produce large quantities of wood off-cuts and sawdust, and these, the sawdust and off-cuts are supposed waste. The methods used for the disposal of the supposed waste are resource and energy demanding, thus increasing the organizational operating costs. Allied Timbers Zimbabwe, is such an organisation, it is a wood processing company in located in Manicaland, Zimbabwe. The quantity of off-cuts and saw dust produced daily is not known. However with the knowledge of the timber daily output of the company and the percentage of useful wood on each individual tree, the waste output can be estimated by calculation. Table 1 below shows the estimated amount of waste produced per day during the wood processing from the cutting down of trees to when the processed timber is ready for the market.

Table 1. Waste output quantities

| Process | Volume per day in m ³ | Mass of 30% moisture patula pine in kg |
|-------------------|----------------------------------|--|
| Forest Operations | 89 | 22 250 |
| Saw Milling | 79 | 19 750 |



Figure 1. Wood Incinerator

The plant's supposed waste produced is then transported to an incinerator by a conveyor belt. Figure 1 shows the incinerator, where the supposed waste is combusted. Apart from the advantage of providing electricity for a community, gasification provides a solution for the socio-environmental problems of smoke from burning waste. To estimate the amount of energy that can be obtained from biomass, according to Rajvanshi, (1986), for wood fuel in gasifiers, $1\text{ kg biomass} \cong 2.5\text{ m}^3\text{ woodgas}$ The energy conversions below were taken from (Hofstrand, 2007) neglecting the fuel conversion efficiencies. 1 litre of gasoline produces, $1\text{ L} = 34.8\text{ MJ} - \text{HHV} = 32.2\text{ MJ} - \text{LHV}$
 1 litre of diesel produces: $1\text{ L} = 38.7\text{ MJ} - \text{HHV} = 35.9\text{ MJ} - \text{LHV}$, For wood - 20% moisture content $3\text{ kg} \cong 7.5\text{ m}^3 = 45\text{ MJ}$, Comparing the three types of fuel, using the lower heating values (LHV), 1 litre of petrol produces 8.94kWh at cost of US\$1.30, 1 litre of diesel produces 9.97kWh at cost of US\$1.15, 3kg of wood produces 12.5kWh at cost of US\$0, since its free (supposed waste)

Utilization of the wood off-cuts to produce power saves on the costs of disposing them. Gasification by-products are ash and wood tar. Ash is valuable as it contains nutrients taken in during plant growth and are not combusted during burning of the wood. Ash can be used as fertilizer, having advantages of low cost over the NPK fertilizers (Adekayode et al, 2010). Results for using wood ash as fertilizer were also published by (Melese & Yli-Halla, 2016). Other uses of ash include neutralizing acidic soils, deter slugs and snails in gardens, polishing glass, silver and metal.

2.1 Gasification

Gasification is the production of syngas (producer gas) by partial combustion of biomass at temperatures of about 1000°C (Rajvanshi, 1986). Gasifiers usually have four regions, combustion, reduction, pyrolysis and drying region. In the combustion and reduction zones that's where the gasification chemistry occurs (Muzee, 2012). The reactions that occur in each region are discussed below (FAO, 1986). Solid fuels are usually composed of combustible elements carbon, hydrogen and oxygen. The products of complete combustion are carbon dioxide and steam (water vapour). The reactions are exothermic, yielding theoretical temperature of 1450°C. The carbon dioxide and steam are then reduced to methane, hydrogen and carbon monoxide which are the combustible components of syngas. Major reactions are:

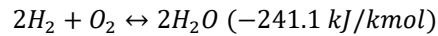
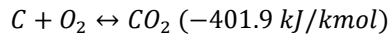

The important reactions that occur in the reduction zone are between the solid reactants and the combustion produced gases. The solid reactants are usually hot charcoal. The following chemical reaction happen in the reduction zone

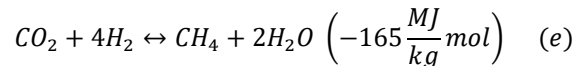
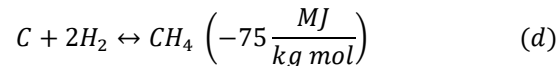
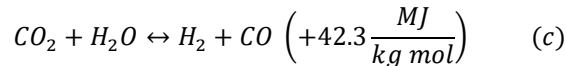
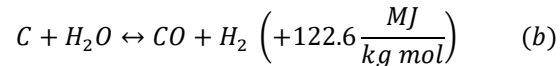
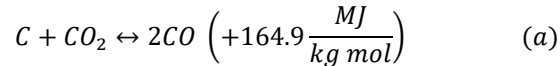

Equations (a) and (b) are the main reduction reactions, they are endothermic thus they require heat energy input. Reaction (a) is known as the Boudouard reaction, occurs around 800°C and (b) as the water gas, where steam and carbon react. Equation (c) is called the water-gas shift reaction. Equation (e) is the Sabatier process, carried at high temperatures (300 - 400°C) and in presence of nickel catalyst or ruthenium on aluminium oxide.

2.2 Engine Power Output

The power output from an internal combustion engine is determined by the following factors such as; heating value of the fuel entering the engine, amount of fuel entering the engine, engine efficiency to convert thermal energy to mechanical energy and number of combustion strokes of engine per given time. The heat value of the syngas is dependent on the syngas composition. (Russel, 2008). The table 2 below shows the heating values of the gasification products methane, carbon monoxide and hydrogen gas.

Table 2. Syngas properties

| Gas | Eff. Heating kJ/mol | Value kJ/m ³ /l | Stoichiometric Oxygen demand (m ³ /m ³) |
|-----------------|---------------------|----------------------------|--|
| Carbon monoxide | 283 660 | 12 655 | 0.5 |
| Hydrogen | 241 300 | 10 770 | 0.5 |
| Methane | 801 505 | 35 825 | 2.0 |

To achieve combustion it is however of importance that the right quantity of air is supplied to the fuel. The amount of fuel entering the engine is determined by the cylinder volume and the pressure of the gas at the time the inlet valve closes. For a given engine the cylinder volume is a constant. The pressure of the syngas in the engine depends on engine characteristics, speed of engine, and pressure of the syngas at the inlet manifold (Hardy, 1996). The pressure at the inlet manifold is dependent on the pressure drop across the entire gasification system that is gasifier cooler/cleaner and gas/air carburettor. Engine efficiency is the efficiency at which an engine can convert thermal energy of the fuel into mechanical power, depending in the first instance on the compression ratio of the engine. Higher compression ratios up to 1:11 can be used for syngas resulting in higher thermal efficiencies and increase in engine shaft power. Engine power output depends on the engine speed since engine power output is defined per unit time. For the spark ignition engine, power increase is less than linear reason being because of changes in efficiency factors. For diesel engine, the power output is nearly linear with the rpm (All Power Labs, 2018). For syngas powered engines, the speed is limited by the combustion velocity of the combustible syngas-air mixture. The syngas can then be cooled and filtered before being used as a fuel in the internal combustion engine. The four separate zones in the gasifier are:

- a. Drying – the gasifier fuel is dried by removal of the moisture
- b. Pyrolysis – at temperatures above 250 °C, char is formed from the fuel
- c. Combustion – combustion of the char at temperatures around 1200 – 1500 °C
- d. Reduction – combustion products are reduced by the hot charcoal bed forming syngas

2.3 Available gasifiers Technologies

There are fixed bed gasifiers (Updraft, downdraft and cross-draft) are less expensive and simpler whilst the fluidised bed gasifiers are relatively complicated and generate gas with high tar content (FAO, 1986).

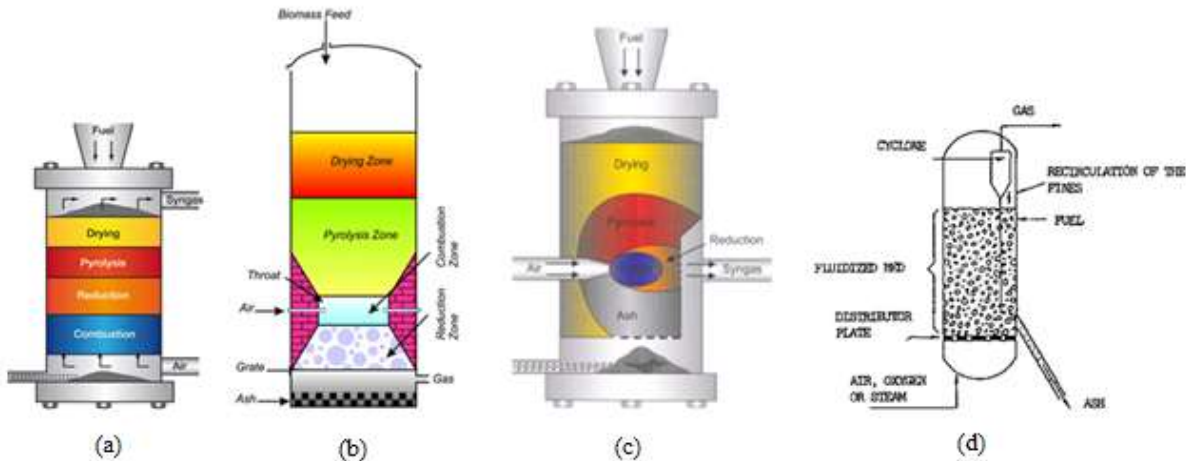

Figure 2. Gasifier concepts (a) Updraft (b) Downdraft (c) Cross-draft (d) Fluidized bed

The updraft gasifier also referred to as counter-current gasifier, the oldest and simplest gasifier. The advantages for such a set up are; good thermal efficiency, high charcoal burn out, little tendency towards slag, formation and small pressure drop while the disadvantages are; relatively long time required to start-up an I.C.E, high sensitivity to tar and moisture content of fuel, poor reaction capability with heavy gas load (Colpan et al, 2010). For the downdraft gasifier, the gasification air is introduced at the top of the reactor or on top of the combustion zone. The fuel is introduced into the gasifier at the bottom of the reactor. The syngas is collected from the bottom of the reactor. The hot charcoal bed reduces the gases produced, resulting in syngas in abundance of hydrogen, carbon monoxide and methane. This type of gasifier can produce tar free syngas which can be readily used as fuel for a combustion engine. The advantages are that it can produce tar free syngas, has low sensitivity to charcoal dust and tar content of fuel and flexible adaptation of gas production to load but it is not feasible for small particle size of fuel and design tend to be tallish. Cross draught gasifiers are an adaptation for use of charcoal as fuel. Charcoal gasification results in high temperatures of about 1500°C, which cause material problems. The insulation of the high temperatures is produced by the charcoal itself. The advantages for this type are; short design height, fast response time to load and flexible gas production while the disadvantages are; minimal tar conversion capabilities, require high quality charcoal, high pressure drop, high sensitivity to slag formation.

The operation of the updraft and downdraft gasifiers is influenced by the morphological, chemical and physical properties of the fuel. Problems normally encountered include lack of bunker-flow, slagging and extreme pressure drop. The fluidised bed was designed to counter for the mentioned challenges. The fluidised bed gasifier has high velocity air blown through a bed of solid particles which keeps the particles in suspension. The bed is externally heated and then biomass is introduced when the bed has reached sufficient temperature (Gupta, 2005). The biomass is introduced at the lower part of a reactor, gets rapidly mixed with the high temperature bed material and almost instantly heats up to the bed temperature. Thus the biomass is quickly pyrolysed resulting in a relatively large sum of gaseous materials. Further gasification and tar-conversion reactions occur in the gas phase. The ash particulates carried over to the top of the reactor have to be removed from the syngas. It is advantageous in that it is easy to control temperature and fluffy and fine grained material can be used as fuel but has high tar content syngas, incomplete carbon burn out, poor response to load changes

Most wood species have low ash content which makes them suitable for fixed bed gasifiers. Because of high volatile content of wood, updraft systems produce tar containing gas suited for direct burning. Cleaning the gas to make it suitable for engines is rather difficult and labour intensive. Downdraft gasifiers can be designed to deliver virtually tar-free syngas in a certain capacity range when fuelled by woodblocks or wood chips of low moisture content (Gautam, 2010). After passing a relatively simple clean up train the gas can be used in internal combustion engines. Most downdraft gasifiers in existence are not suitable for un-pelletized sawdust. Some of the problems encountered include lack of bunker flow, inadmissible pressure drop and excessive tar production. However sawdust can be used as fuel in fluidized bed gasifiers producing combustible gas for heat. As for engine applications, additional clean up systems are of necessity (Das, 2011).

3. Research Methodology

3.1 Identification of Gasification Fuel

The biomass which can be used as fuel in a gasifier are charcoal, wood and wood waste (wood off-cuts and sawdust), agricultural residues (rice husks, maize cobs and cereal straws) and peat. However as a result of the differences in chemical and physical properties, a gasifier has to be designed for a specific fuel (FAO, 1986). Some of the fuel properties are listed below. The choice for fuel for the gasifier is partly based by the fuel's heating value. Fuel with higher heating value produce more power in the internal combustion engine. Table below shows the heating values of 3 common gasifier fuels. The heating value of the syngas produced is partly dependent on the moisture content of the feedstock. High moisture content reduce the thermal efficiency (Abadie, 2009). For downdraft gasifiers, high moisture content may result in lower temperatures in the oxidation zone, which lead to high tar content, and lower heating value of the syngas. Moisture content less than 25% is tolerated. The quantity of volatile matter in the biomass will determine the necessity of special measures of removing tars from the product gas in engine applications. High quality charcoal does not need this special attention. For biomass fuel with more than 10% volatile matter, downdraft gasifiers are more suitable. (Mahapatra, 2016)

Ash can cause major problems in gasifiers like clinker formation in the reactor, thus will add to the labour required to the gasifier. Slagging may lead to excessive tar formation as well as complete blockage of the reactor. Whether or not slagging happens depends on the ash content of fuel, the melting characteristics of the ash, and temperature pattern in the gasifier. For ash content below 5 - 6 %, no slagging is observed. Reactivity of the fuel is important as it helps determine the rate of conversion of carbon dioxide to carbon monoxide. Gasifier operational characteristics like re-starting after temporary shut-down are greatly affected by the reactivity of the char produced in the gasifier. Fuels such as charcoal, wood and peat are more reactive than coal. The surface available for reduction is influenced by the grain size and porosity of the char, which in turn determines the rate of reduction reactions. Reactivity of char can be improved by steam treatment or by treatment with lime and sodium carbonate. The quantity of volatile matter in the biomass will determine the necessity of special measures of removing tars from the product gas in engine applications. High quality charcoal does not need this special attention. For biomass fuel with more than 10% volatile matter, downdraft gasifiers are more suitable. Ash can cause major problems in gasifiers like clinker formation in the reactor, thus will add to the labour required to the gasifier. Slagging may lead to excessive tar formation as well as complete blockage of the reactor. Whether or not slagging happens depends on the ash content of fuel, the melting characteristics of the ash, and temperature pattern in the gasifier. For ash content below 5 - 6 %, no slagging is observed.

Reactivity of the fuel is important as it helps determine the rate of conversion of carbon dioxide to carbon monoxide. Gasifier operational characteristics like re-starting after temporary shut-down are greatly affected by the reactivity of the char produced in the gasifier. Fuels such as charcoal, wood and peat are more reactive than coal. The surface available for reduction is influenced by the grain size and porosity of the char, which in turn determines the rate of reduction reactions. Reactivity of char can be improved by steam treatment or by treatment with lime and sodium carbonate. For the downdraft and updraft gasifiers there is a limited range of fuel size acceptable as biomass feed. Fine grained as well as fluffy feedstock can cause flow problems in the Gasifier bunker and high pressure drop over the reduction zone. Large pressure drop leads to reduction of the gas load which results in low temperatures and high tar production. Large particle size give rise to reduced reactivity of fuel which results in start-up problems and poor gas quality, and transporting problems through the equipment. Wood gasifiers generally operate on wood chips ranging from 8*4*4 cm to 1*0.5*0.5 cm. Bulk density is the weight per unit volume of the loosely tipped fuel. Fuels with high bulk densities have high energy for volume value, hence they require less bunker space for a particular refuelling time. Low bulk density biomass may give rise to unsatisfactory flow under gravity. Determining the bulk densities of wood, peat and charcoal were compared. Some feedstocks like softwoods produce char that has tendency of disintegrating. In extreme cases this may lead to inadmissible pressure drop. Tropical hardwoods tend to have long residence time in the pyrolysis zone which leads to bunker flow problems, tar entrainment and low gas quality.

4. Results and Findings

4.1 Energy Content of Wood, Saw dust and Charcoal

Fuel with higher heating value produce more power in the internal combustion engine. Table below shows the heating values of 3 common gasifier fuels. Wood is a viable fuel source based on the lower heating values found in table 4.

Table 3 Average Lower Heating Values

| Fuel | Moisture content (%) | Lower heating value (kJ/kg) |
|----------|----------------------|-----------------------------|
| Wood | 20 – 25 | 13 – 15 000 |
| Charcoal | 2 - 7 | 29 – 30 000 |
| Peat | 35 - 50 | 12 – 14 000 |

4.2 Hearth sizing

For the gasifier throat

$$B_g \max = \frac{0.9m^3}{cm^2h} = \frac{gas\ intake}{throat\ area(A_t)} \quad 0.9 = \frac{3600 \times 0.0132}{A_t} \quad \therefore A_t = 52.8cm^2$$

$$\text{But } A_t = \frac{\pi}{4}d^2, \text{ hence diameter } \therefore d = \sqrt{\frac{4 \times 52.8}{\pi}} = 8.2cm$$

Hence the diameter of the throat is 80mm.

4.3 The Selection and Design of a proper Gasifier (The Starved-bed Gasifier (SBG))

The Starved-bed Gasifier (SBG) was selected and designed. The Woodchips, sawdust briquettes were used in the chosen *Starved-bed Gasifier* to power a sized I.C.E with parameters shown in table 4 with a rated power of 17.74kW. The

Table 4 Starved-bed Gasifier unit specifications of design outputs

| Item | Design value |
|----------------------|--|
| Rated power | 17.74kW |
| Generator Max Output | 31kVA |
| Fuel type | Woodchips, sawdust briquettes (sizes 20mm to 50mm) |
| Fuel consumption | 22kg/hr. for wood chips |

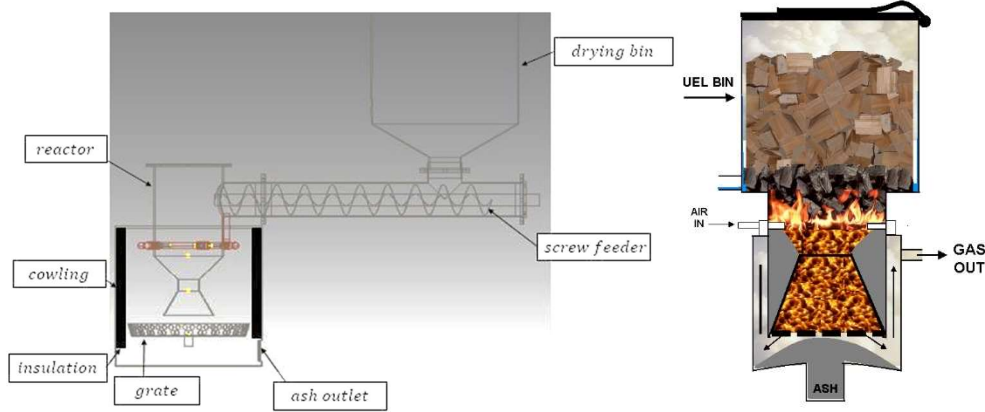

Figure 4. (a) The SBG feed system; (b) Conventional feed concept used for SBG design

For the SBG, as shown above, the biomass feed will be achieved by employing the feed screw, which can be used to control the biomass feed by the number of rotations it makes. The raw biomass is stored in a separate unit (temporary storage) from the reactor.

4.4 Tests and Results from the test run

A Gasifier prototype was fabricated at the University Of Zimbabwe workshop and some tests were carried out. The goal was to run a generator with the syngas. A simple gasifier was designed and was intended to power a 1.8kW petrol generator. Figure 6.4 below shows a schematic of the prototype layout

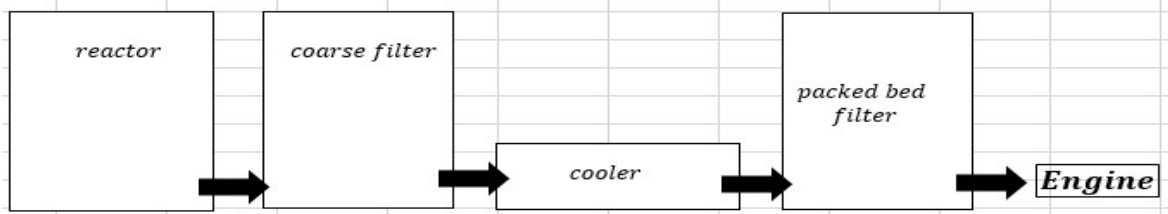

Figure 5 Prototype gasifier layout

The syngas from the reactor enters the coarse filter which was a substitute of cyclone filter, the coarse filter was filled with the wood off cuts of different sizes. The purpose for this filter was to remove the particulates entrapped in the gas. The filtered gas then entered a water cooler, which served to cool the gas. At room temperature CO, H₂ and CH₄ are in gaseous state whilst tar would be in liquid form. The cooler was meant to cool syngas to room temperature so that the tars would condense which makes it easier to separate the liquid tar from the gas. After the cooler, the gas enters the packed filter bed, which has different filter materials which were meant to scrub of the liquid condensate from the syngas. There were three layers of material in the packed bed filter, firstly there were wood off cuts, followed by wood shavings and lastly cloth material.

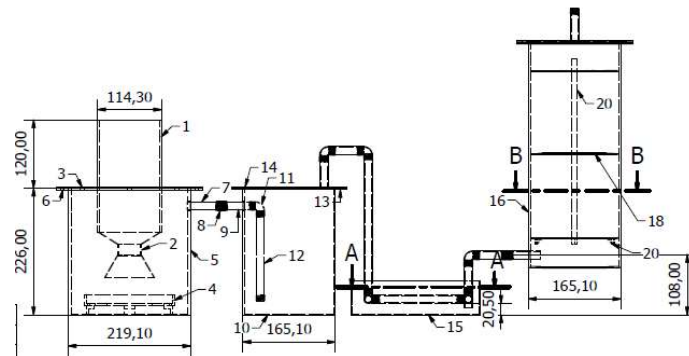

Figure 6 Prototype engineering drawing

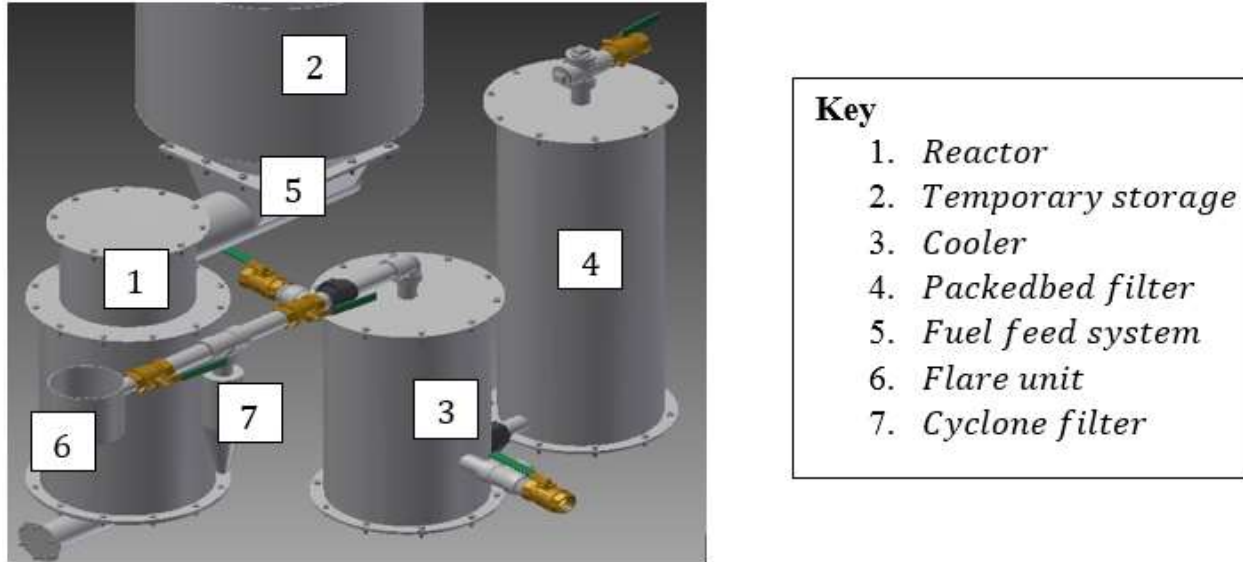

Figure 7 Starved-bed gasifier 3D solid works Design



Figure 8 Fabricated Sub-Assemblies of actual prototype layout

Figure 9 is a demonstration of how combustible the syngas from wood pyrolysis from a gasifier works hence it can also drive an internal combustion engine. Air flow was provided by air compressor at the workshop. When we used the compressor there was higher air flow rate than required by the Gasifier hence the syngas react with the excess oxygen forming carbon dioxide and water, the non-combustible gases. On reducing the gasifying air the, the syngas combusted very well.



Figure 9 Syngas burning (University of Zimbabwe Mechanical Engineering Workshop)

5. Discussion and Recommendations

It is of importance that a gasifier be coupled to the specific generator it was designed for. If a smaller power rated generator is used instead, the generator will provide insufficient suction in the gasifier reactor. This will lead to lower bed temperatures and as a result high tar production. If the generator used is of higher power rating, there will be insufficient gas production that meets that generator's requirement, thus there will not be sufficient fuel for the generator hence it might not run. The generator and gasifier should have a proper relationship, the gasifier should be able to supply the right amount of gas to the generator and the generator should be able to provide enough suction in the gasifier reactor. For the prototype fabricated at the University of Zimbabwe, there were problems with gas leakages and the gasifying air supplied by the compressor provided high flow rates. Air leakages into the gasifier system especially in the reactor is dangerous as it may result in explosions. Air leakages in the system resulted in gas escaping thus little gas reached the intended destination that is the engine. The high flow rates from the air compressor resulted in too much gasifying air hence there was complete combustion, and the complete combustion products are not combustible. However positive results were obtained, without the use of air compressor to supply the gasifying air and the temporary fixing of air leaks. Using the natural air flow, combustible gas was produced. Thus to carry on with the project, a suction blower is required, as well as fixing of gas leaks from or into the gasifier system. An optimum air draft velocity is to be determined experimentally in order to optimise yield of syngas. The grate should rotate so as to avoid clogging in the reactor. Clogging will result in large pressure drops in the system and thus inadequate gas flow will also result. For grate rotation a battery and a DC motor would be required, the battery will be providing the motor with electric energy which it will convert to mechanical energy which is then transferred to the grate shaft. Another addition required would be an automatic ash removal system, thus a few additions required to the ash cylinder. A screw conveyer, a DC motor and battery would enable the automation. Continuous flow of water is also required hence a pump is to be installed. The continuous flow of water can be used as heat recovery system, where the heat gained from the syngas can be conveyed to where heat is required. The heat may be used for industrial purposes that require heat and or steam. The gasifier will be operating in the Combined Heat and Power mode, thus it will be providing power and providing heat during its operation. Timber processing companies can operate off grid by utilizing their waste to generate electricity. With the wood consumption of approximately 2kg per kWh, thus say for a 500kW Gasifier system, operating for 18hours a day, approximately 14tonnes of wood waste would be required per day.

The grid tariff in Zimbabwe is US\$9.83c, thus the company can save as much as US\$17000 every month on the electric bill as well as cut on the waste disposal costs. By generating electricity from waste, landfills and incineration could be avoided, thus reduction of land and air pollution. Municipal Solid Waste can also be used to generate electricity by the gasification process. Municipalities can refrain from the current practice of landfills, and employ the Gasification technology to generate either chemicals, liquid fuels or electricity.

6. Conclusions

Internal combustion engines require syngas with tar content below 15mg/Nm³, too much tar above this threshold can cause problems during engine operation and pipe blockages. For the starved bed gasifier tests are required to be conducted to test the effectiveness of the gas cleaning system. Improvements on the packed bed filter may be required, as well as adding some materials like pressure and temperature sensors. During the scrubbing operation, the condensed tar may block the filter perforations hence it is of necessity to be able to measure the pressure drop across the filter. With such a system, the gasifier would be allowed to operate within a specified range of pressure drop. If the pressure drop exceeds a specified maximum, then cleaning or replacement of the filter material would be required. To build an effective heat exchanger the gas temperature at the cooler inlet should be determined. Temperature sensors are required to be installed in the gasifier reactor, these will serve to notify an operator if the gasifier is operating at normal conditions.

Acknowledgements

The authors are grateful to the various companies that allowed the researchers access to their operations to carry out this research and indeed very thankful for accepting the adoption of the research findings.

References

- Abadie, L.M and Chamorro, J.M., The Economics of Gasification: A Market-Based Approach, *Energies*, 2, pp. 662 – 694, 2009.
- Adekayode, F.O. and Olojugba, M.R., The utilization of wood ash as manure to reduce the use of mineral fertilizer for improved performance of maize (*Zea mays* L.) as measured in the chlorophyll content and grain yield, *Journal of Soil Science and Environmental Management*, vol. 1 no. 3, 2010.
- All Power Labs, *GEK Gasifier Kit, Complete System for Converting Biomass to Syngas*, Available: http://www.allpowerlabs.com/wp-content/uploads/2012/11/GEKOneSheet10_20_15Small.pdf, Accessed: 15 June 2018.
- Colpan, C.O, Hamdullahpur, F., Dincer, I. and Yoo, Y., Effect of gasification agent on the performance of solid oxide fuel cell and biomass gasification systems, *International Journal of Hydrogen Energy*, vol. 35, no. 10, pp. 5001-5009, 2010.
- Das, D.K., Dash, S.P. and Ghosal, M.K., Performance Study of Dual Fuel Engine Using Producer Gas as Secondary Fuel, *World Renewable Energy Congress – Sweden*, pp. 3541 – 3548. 2011.
- FAO, *The future of wood gas as engine fuel*, Food and Agricultural Organisation of the United Nations, Chapter 7, Rome, Italy, ISBN 92-5-102436-7, Forestry Paper 72, 1986.
- Gautam, G., 2010, Parametric Study of a Commercial-Scale Biomass Downdraft Gasifier: Experiments and Equilibrium Modeling, *MSc Thesis*, Department of Mechanical Engineering, Auburn University, Alabama, 2010.
- Gupta, J., *A textbook on machine design*. First Multi-color Edition, New Delhi: Eurasia Publishing House, 2005.
- Hardy, C.C., *Guidelines for estimating volume, biomass, and smoke*, Seattle: Pacific Northwest Research Centre, 1996.
- Hofstrand, D., *Energy Measurements and Conversions*, IOWA University, 2007.
- Jacobson, M. Z., Providing all global energy with wind, water, and solar power, Part I: Technologies, energy resources, quantities and areas of infrastructure, and materials, *Energy Policy*, p. 16. 2010
- Mahapatra, S., Experiments and Analysis on Wood Gasification in an Open Top Downdraft Gasifier, *PhD Thesis*, Indian Institute of Technology, Bangalore, 2016.
- Melese, A. and Yli-Halla, M., Effects of applications of lime, wood ash, manure and mineral P fertilizer on the inorganic P fractions and other selected soil chemical properties on acid soil of Farta District, Northwestern highland of Ethiopia, *African Journal of Agricultural Research*, vol. 11, no. 2, pp. 87 – 99, 2016.
- Mpofu, E. M., Dema plant: A case of sleaze and pollution, *Zimbabwe Independent*, 2016, Available: <https://www.theindependent.co.zw/2016/10/07/dema-plant-case-sleaze-pollution/>, Accessed: 15 June 2018.
- Muzee, K. wa Gathui, T. and Wanjiru, H., *Biomass Gasification: The East African Study*, Practical Action Consulting, 2012.
- Nanthavong, K. and Xayalath, B., Promotion of the Efficient Use of Renewable Energies in Developing Countries, *REEPRO Rural Renewable Electrification*, Issue EIE-06-256, 2008.

- Rafidah, J., Sakanishi, K., Miyazawa, T., Mohd Nor, M.Y., Asma, W., Mahanim, S.M.A., Shaharuddin, H. and Puad, E., Effects of different Gasifying Agents on Syngas Production from Oil Palm Trunk, *Journal of Tropical Forest Science, Journal of Tropical Forest Science*, vol. 23, no. 3, pp. 282–288, 2011.
- Russell, A., *Producer Gas for Power Generation*, Practical Action, 2008, Available: http://medbox.iiab.me/modules/en-practical_action/Energy/Fuels%20and%20engines/producer_gas.pdf. Accessed: 15 June 2018.
- Rajvanshi, A.K., *Biomass Gasification, in: Alternative Energy in Agriculture*, Maharashtra: CRC Press, 1986.
- Sharma, G., Performance Evaluation of High Pressure Down Draft Biomass Gasifier for BIG/GT Applications, *International Journal of Engineering Research*, vol. 5 no. 2, pp. 499 – 505, 2016.
- Stassen, H.E., Small-Scale Biomass Gasifiers for Heat and Power, World Bank Technical Paper Number 296, *Energy Series*: ISBN 0-8213-3371-2, 1995.

Biographies

Simon Chinguwa is currently a Lecturer in the Department of Mechanical Engineering at the University of Zimbabwe. He holds a Bachelor of Engineering Honors degree in Industrial and Manufacturing Engineering from the National University of Science and Technology and an MSc degree in Manufacturing Systems and Operations Management from the University of Zimbabwe. His main areas of research and teaching are in Solid Mechanics, Thermodynamics and Energy Efficient Machines. He is currently enrolled with the University of Johannesburg in South Africa, pursuing research focusing on alternative clean energy efficient fuels to power internal combustion engines.

Wilson R. Nyemba holds a BSc Honors degree in Mechanical Engineering from the University of Zimbabwe and an MSc in Advanced Mechanical Engineering from the University of Warwick in England. He held several positions in industry ranging from product development to engineering management and has served as a Lecturer, Chairman of Department and Dean of Engineering at the University of Zimbabwe. He also served as Chairman of WaterNet and Project Manager for the Royal Academy of Engineering Project on Enriching Engineering Education, both in Southern Africa. He is currently on sabbatical at the University of Johannesburg in South Africa, pursuing research focusing on Manufacturing Process Flow Modelling and Simulation using Engineering Systems Thinking.

Tien-Chien Jen is a Professor of Mechanical Engineering and Head of the Department of Mechanical Engineering Science in the Faculty of Engineering and the Built Engineering at the University of Johannesburg.

Kudzai Boora is a final year Mechanical Engineering student at the University of Zimbabwe. His main interests are in mechanical engineering design, thermodynamics and renewable energy. He gathered substantial experience from a company in South Africa that specializes in the design of waste heat recovery systems as well as collecting the data at the company for this research.